

INSTALLATION INSTRUCTIONS

VEHICLE APPLICATION

Year: **2011 - 2014**
Make: **Polaris**
Model: **RZR 900, RZR 4 900, RZR XP 900, RZR XP 4 900,**
Engine: **875cc**

TOOLS REQUIRED

- 2.5mm, 4mm, 5mm Hex Key
- 10mm, 13mm Wrench/Socket
- 5/16" Nut Driver
- 1/4" Drill Bit
- Phillips Screwdriver
- T27 Torx
- Wire Cutters
- Pilot Hole Punch
- Tape
- Razor Blade
- Hole Saw (Included with Kit)
- Power Drill

BEFORE YOU START

- Please read the entire installation manual before proceeding.
- Ensure all components listed on page 12 are present.
- If you are missing any of the components, call our customer support at (909) 947-0015.
- Do not work on the vehicle while the engine is hot.
- Make sure the engine is turned off, the vehicle is in Park and the Parking Brake is set.

THREAD LOCKER USE

We have provided a small tube of thread locker in your kit. Whenever you see the symbol above on a step of the instructions apply 1 small drop of the thread locker to the threads of the screws or bolts. This will keep your hardware from vibrating loose during rough driving. If the hardware ever needs to be removed, do so slowly to avoid having the inserts strip out from the plastic.

WARNING:

THIS EQUIPMENT SHOULD BE INSTALLED, ADJUSTED, AND SERVICED BY PERSONNEL FAMILIAR WITH THE CONSTRUCTION AND OPERATION OF THIS TYPE OF EQUIPMENT AND THE HAZARDS INVOLVED. FAILURE TO OBSERVE THIS PRECAUTION COULD RESULT IN SEVERE INJURY. READ THIS MANUAL THOROUGHLY AND MAKE SURE YOU UNDERSTAND THE PROCEDURES BEFORE YOU ATTEMPT TO OPERATE THIS EQUIPMENT. THE PURPOSE OF THIS MANUAL IS TO PROVIDE YOU WITH INFORMATION NECESSARY TO SAFELY OPERATE, MAINTAIN, AND TROUBLESHOOT THIS EQUIPMENT. DO NOT USE THIS EQUIPMENT FOR ANY REASON OTHER THAN ITS INTENDED PURPOSE. FAILURE TO FOLLOW THESE INSTRUCTIONS WILL VOID ANY WARRANTY. KEEP THIS MANUAL FOR FUTURE REFERENCE. THE INFORMATION CONTAINED IN THIS MANUAL IS SUBJECT TO CHANGE WITHOUT NOTICE.

Product will intake and expel both air and loose materials with high force and velocity.

- Install product on roll cage, ensure air inlet is not blocked.
- Install product securely to roll cage and avoid placing hair, extremities, clothing, or other loose material in front of air inlet during use.

Moving parts are sharp and could cause personal injury.

- Keep fan safety guard and exhaust cover in place while operating and after service.
- Disconnect product from power source before servicing.

Scavenge Fan is designed for use in conjunction with an UTV's operating manual, and state and federal law.

- Keep your seat belt fastened and wear a helmet while operating the vehicle.

Risk of electric shock!

- Improper installation, maintenance or operation could cause serious injury or property damage.

Cut Hazard!

- Please read through the warning sheet included with the hole saw before starting your project.
- Improper operation of the hole saw safely could cause serious injury or property damage.

SEE EXPLODED VIEW ON PAGE 11

INSTALLATION INSTRUCTIONS (CONTINUED)

1. Remove the plastic air inlet cover and foam insert. Set aside, these parts will be reused later.



2. Remove the driver side rear fender by removing a total of nine (9) screws using a T27 Torx screwdriver. There are five (5) screws along the outer edge of the fender, three (3) near the door, and one (1) at the very bottom of the fender (shown in Step 3).

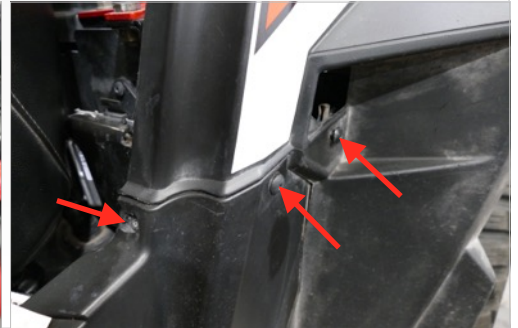

3. The last screw can be found on the bottom of the rear fender.



4. Once the screws are removed, lift the fender up and out to remove it from the vehicle. Note the locations of the U-nuts as the fenders are sometimes the U-nuts are dislodged when removing the fender.



5. Use a T27 Torx screwdriver to remove the four screws securing the resonator.



6. Remove the crankcase vent hose by reaching behind the resonator and pulling the hose towards the vehicle. The plastic snap bushing can stay in the resonator, it will not be needed.

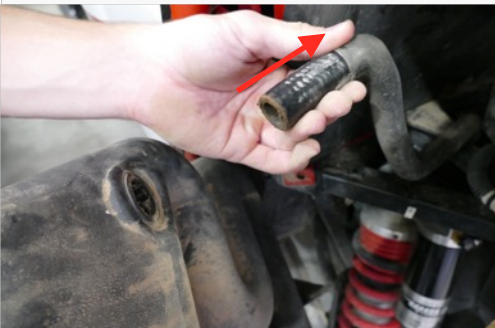

7. Use a flat blade screwdriver to loosen the stock hose clamp. Leave the hose clamp on the stock intake tube, this clamp will be reused later. Once the hose clamp is loosened, the resonator can be removed by pulling it out of the stock intake tube and away from the vehicle.

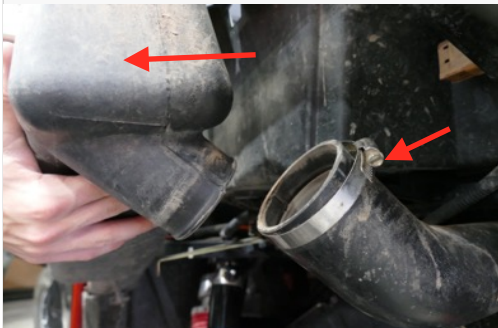

8. Use a 13mm wrench to remove the two stock screws securing the stock bracket. Set these screws aside, they will be reused in the next step.



9. Install Bracket (Q) in the same location where the stock bracket was just removed, reusing the stock screws from Step 8.



10. On Page 9 of this instruction manual you will find a drill template. Cut out this drill template along the straight edges. This will be used to locate the correct drill location.

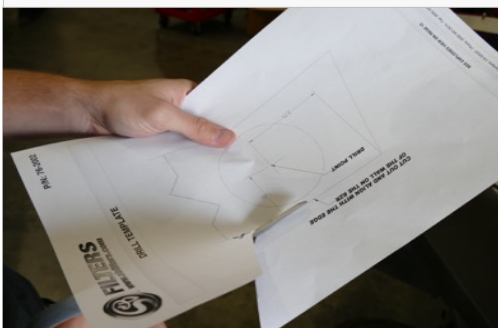

11. Align the edges of the drill template with the edges on the driver side wall of the cargo bed, use tape to secure the template to the wall. Double check that the hole will be entirely on the face of the wall and centered so that it does not extend beyond the edges of the wall.



SEE EXPLODED VIEW ON PAGE 11



INSTALLATION INSTRUCTIONS (CONTINUED)

12. Use a hole punch to make a drill point, then drill through the cargo wall with a 1/4" drill bit to create a pilot hole for the hole saw drill bit.



13. Attach the provided Hole Saw Drill Bit (AD) to a power drill and line up the drill bit with the template and pilot hole you created in the previous step. Proceed to read both Step 14 and the warning sheet before attempting to use the hole saw.



14. Start cutting slowly and then progressively increase the speed of the drill as you go. Doing so should give you a better cut. Try to keep the Hole Saw Drill Bit (AD) as flat to the wall as possible.



15. Once you have completely drilled through the wall, remove the cutout template then use a deburring tool to clean up any burrs that may be present on the edge of the cut.



16. Insert the Wall Grommet (L) into the hole.



17. Insert the Adapter Tube (M) through the Wall Grommet (L) in the cargo bed. Stop when the tube hits the wall grommet. The tube should be facing the same direction as shown in the pictures below.



18. Place two #52 Hose Clamps (P) onto Coupler (O), then slide the coupler onto the end of the Intake Tube (N). Leave both hose clamps loose for now.



19. Screw the threaded end of the Hose Barb (R) into the Intake Tube (N). Tighten the hose barb until the end of the hose barb (R) is pointing toward the front of the vehicle. The angle of the Hose Barb (R) may have to be adjusted for best fitment with the crankcase hose.



20. Connect the Intake Tube (N) to the Adapter Tube (M) by inserting the open end of the Coupler (O) onto the end of Adapter Tube (M) that you installed in Step 17. Once the coupler is in place and the tubes are connected, insert the free end of Intake Tube (N) into the stock intake tube. Do not tighten any hose clamps during this step.

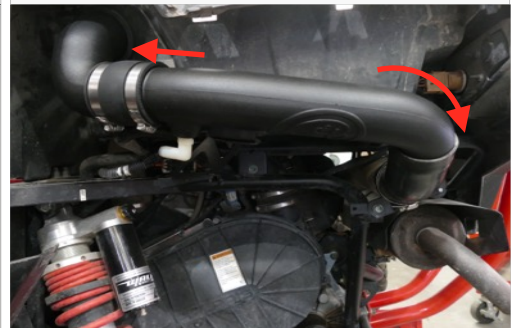

21. Use the Screws (H), Lock Washers (S), and Washers (F) to secure the Bracket (Q) to Intake Tube (N).



22. Make sure all tubes (M & N) and Coupler (O) are aligned correctly, then fully tighten the hose clamps on the coupler and stock intake tube.



23. For 2011 & 2012 model years you will need to use the provided Extension Hose (AF) and Straight Hose Barb (AE) to connect the stock crankcase vent hose to the Hose Barb (R) in the Intake Tube (N). We have provided extra length and we recommend cutting the extension hose (AF) down to 6" for best fitment. For 2013 & 2014 model years, the use of the extension hose is not needed, connect the stock hose directly to the hose barb on the intake tube.

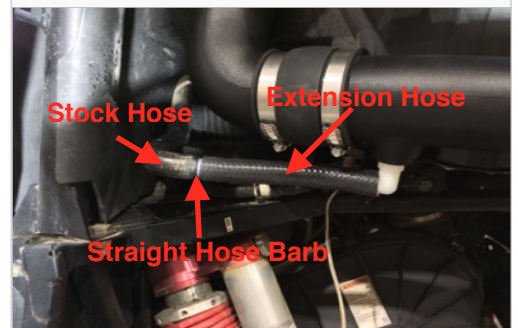

SEE EXPLODED VIEW ON PAGE 11

INSTALLATION INSTRUCTIONS (CONTINUED)

24. Determine where you would like to install the Particle Separator (A) on the roll cage, making sure you have enough room to fit the clamps and Particle Separator on the roll cage without any interference. Planning ahead will save you time during the install. Our clamps are adaptable enough to work around most accessories you may already have installed on the roll cage.



25. Once you have determined where you would like to install the Particle Separator, install the two Straps (E) onto the roll cage. Do not pull the ends of the straps open. Loosely wrap some plastic around the roll cage and push the straps onto the roll cage until they snap into place.



26. Install the Pivot Body (D) onto the Strap (E) with the supplied Screw (J), Locknut (F), and Washer (K) on the roll cage. Do not fully tighten the screws and locknuts. Leave the strap loose. Repeat for both clamps.

27. Install the Adapter (B) on the mounting bosses of the Particle Separator (A) with the supplied Screws (H) and Washers (F). Apply Threadlocker (AG) to the screw before installing. Tighten these screws. Repeat for both sides.

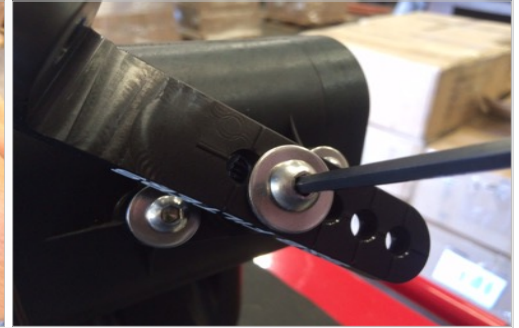

28. Determine the proper angle to mount the L Bracket to the Adapter based on the desired location for the Particle Separator (A). When installing the L Bracket (C), make sure the ribs in the L Bracket are properly seated inside the grooves of the Adapter (B). Do not attempt to rotate these parts once assembled. They are designed to lock into place once seated. Once you're satisfied with these configurations apply Threadlocker (AG) to the Screw (I) then tighten with the Washer (G). Repeat for the other side of the Particle Separator and make sure the L Bracket on both sides are pointed in the same direction and are aligned with each other.

29. Install the L Bracket (C) onto the Pivot Body (D) using Screw (I) and Washer (G). Apply Threadlocker (AG) to the screw before installing. You may have to adjust the position of the Strap (E) and pivot body to get the holes to line up. Do this for both sides. Having an extra pair of hands holding the Particle Separator (A) to help line up the holes will make the install easier.



30. Once you are satisfied with the position, tighten the Screw (J), Locknut (K), and Washer (F) to secure the Strap (D) at the roll cage. Repeat this for both sides.



31. Double check that all screws and locknuts are tight and that they are securely holding the Particle Separator (A) assembly to the roll cage.



SEE EXPLODED VIEW ON PAGE 11

INSTALLATION INSTRUCTIONS (CONTINUED)

32. Insert one end of the Duct (U) onto the Adapter Tube (M), do not tighten. Bring the other end towards the plenum on the Particle Separator (A). Note the length needed to reach the clean air plenum on the Particle Separator. We recommend adding an extra 3" more to the length of the duct needed.



33. Pierce the Duct (U) using a razor, centered between the two wire reinforcements. Cut all the way around, keeping the blade centered between the wire reinforcements the entire length of the cut. Use a mini-bolt or a heavy duty wire cutter to cut through the wire and duct. Use a pair of scissors to cut through any remaining duct not yet cut.



34. (Optional) Regular staples can be used to secure the ends of the strings to the Duct (U).



35. (Optional) For a cleaner appearance, take the end of the wire and tuck it inside the duct. Do this for both ends of the duct if needed.



36. Install the Duct (U) onto the Adapter Tube (M) and the plenum on the Particle Separator (A). Tighten both of the #56 Hose Clamps (T).

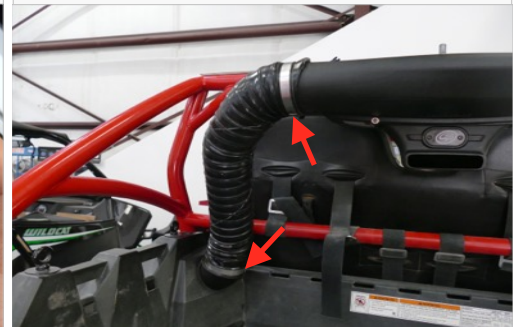

37. Use the provided Velcro Strap (AC) to secure the Duct (U) to the roll cage.



38. Remove the driver's seat by pulling the latch under the seat and lifting up to reveal the battery compartment.



39. Familiarize yourself with the Wire Harness (AA) and each of the connectors. Coming from the relay should be three branches. Wire A is used in conjunction with the Posi-Tap (Z) to tap into a power source. Connector B has the fuse holder with the red and black ring terminals for the battery. Connector C has the connector to power the Particle Separator (A) exhaust fan.

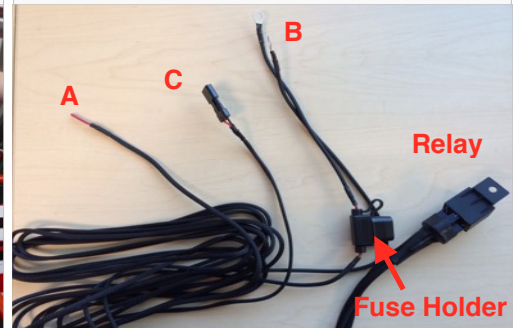

40. Unhook the battery strap.



41. Loosen and remove the nut on the negative battery terminal, then disconnect the terminal from the battery. Repeat for the positive battery terminal. Install the ring terminals, from the Wire Harness (AA), onto the battery terminal clamps. Red wire with the fuse holder to (+) and Black wire to (-) and reinstall the nuts. Secure the positive terminal first and then secure the negative terminal.



SEE EXPLODED VIEW ON PAGE 11

INSTALLATION INSTRUCTIONS (CONTINUED)

42. The Wire Harness (AA) should be routed through the vehicle in such a way that the Wire Harness is protected from direct contact with flying dirt/rocks and other moving parts on the vehicle. The layout shown in this instruction manual serves as a guide for an acceptable location to route the wire harness for a 4-seat RZR. A 2-seat RZR can use a similar method of going through the lower side panel. The extra length added to the wire harness will allow it to be routed in various configurations depending on your vehicle setup. For this install, remove all of the push pins and screws on the lower driver side panel so that the wire harness can be tucked behind this panel and routed to the back of the vehicle.

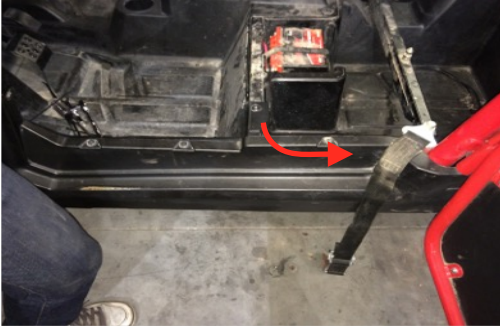

43. Pull the Wire Harness through the lower driver side panel toward the rear driver side wheel well. Route Connector C along the backside of the wall behind the seats, upward toward the cargo area. Wire A will follow the metal frame of the vehicle toward the taillight. Once the routing of the Wire Harness has been determined, strip about 3/8" of insulation off of the end of the Wire A.

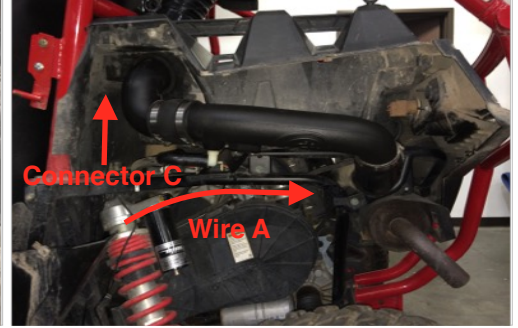

44. Remove the taillight connector by pushing in the tab on the bottom side of the connector, then pull the connector out. The Red/Yellow wire is the power source and where we will tap into.



45. Locate the supplied Posi-Tap (Z) and unscrew the large top cap. Place the cap around the Red/Yellow wire on the taillight connector, then screw the body onto the cap until it is firmly tight and pierces the wire.

46. Unscrew the bottom cap on the Posi-Tap (Z) and insert the Wire A through it. Then insert the wire into the main body of the Posi-Tap, making sure the strands go around the metal core. While holding the wire in place, screw the bottom cap back on until it is firmly tight. Double check both caps to make sure they are tight.

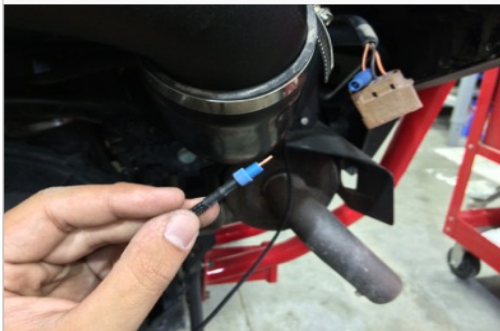

47. Reconnect the taillight connector.

48. Use the Cable Ties (AB) provided to secure the wire to the cage. Use cable ties effectively to secure the harness away from any exhaust components or moving parts that could potentially damage the harness.



49. To ensure that you have installed the Wire Harness (AA) correctly, connect Connector C to the fan connection point on the Particle Separator (A). Note the color of the wires whenever connecting or disconnecting this connector. Make sure not to cross the connectors. Power (red) to power (red) and ground (black) to ground (black). The connector should snap into each other with very little resistance. Do not try to force the connectors into each other. Turn on the ignition and see if the particle separator turns on. If you hear the Particle Separator fan turning on, you have installed it correctly. Proceed to the next step.

SEE EXPLODED VIEW ON PAGE 11

INSTALLATION INSTRUCTIONS (CONTINUED)

50. If you haven't done so already disconnect Connector C and route up the wire through the cargo bed and along the Duct (U) to the Particle Separator (A). Connect the harness into the fan connector.



51. Use Cable Ties (AB) or Velcro Strap (AC) to secure the Wire Harness (AA).



52. Place the battery back down into its compartment and strap down the battery.



53. Group together any excess wires and tie them together with the provided Cable Ties (AB). Use another cable tie and secure the bundle in a place away from any exhaust components or moving parts that could potentially damage the harness. In this install we placed the extra length behind the wall shown below, inside of the lower driver side panel.



54. Reinstall the screws to any panels removed.



55. Reinstall the seats.



56. Reinstall the rear driver side fender removed.



57. Locate the side cover that you set aside from Step 1. Install the Side Cover Plate (V) with the Screws (W), Washers (X), and Lock Nuts (Y).



58. Install the foam insert and side cover back into the rear driver side fender.



59. Make sure the connectors are all plugged in and secure. Turn the ignition on and make sure air is blowing out the exhaust. If the exhaust fan does not turn on, double check your electrical connections. When you turn the ignition off, the fan will stay on for several seconds, and is normal. Your installation is now complete.



SEE EXPLODED VIEW ON PAGE 11

INSTALLATION INSTRUCTIONS (CONTINUED)

SIDE NOTE

S&B recommends that you apply a layer of waterproof grease, such as made by Bel-Ray or Super Lube, on the inside flange of the stock air filter to keep dust from bypassing the seal.

ONGOING MAINTENANCE

Your Particle Separator requires very little, if any, maintenance depending on where you drive; however, you should check to make sure that none of the openings on the front of the Particle Separators are blocked by mud or other debris each time you exit the UTV. You should also make sure the scavenge fan is operating properly. To do so, simply check to make sure the fan is still blowing out air (for about 15-20 seconds) when you turn off your UTV as this is a normal condition. If the fan is not blowing out air or the airflow seems lower than when you initially installed your system, please contact S&B tech support. To clean your Particle Separator, review the cleaning instructions below.

RELATED ITEMS FOR YOUR PURCHASE



Stainless Steel Faceplate
(Brushed)
SKU# 76-3000



Stainless Steel Faceplate
(Polished)
SKU# 76-3001



Stainless Steel Faceplate
(Havasu Red)
SKU# 76-3002



Stainless Steel Faceplate
(Voodoo Blue)
SKU# 76-3003

Order online today at www.sbfilters.com or through your local S&B distributor.

SEE EXPLODED VIEW ON PAGE 11



DRILL TEMPLATE

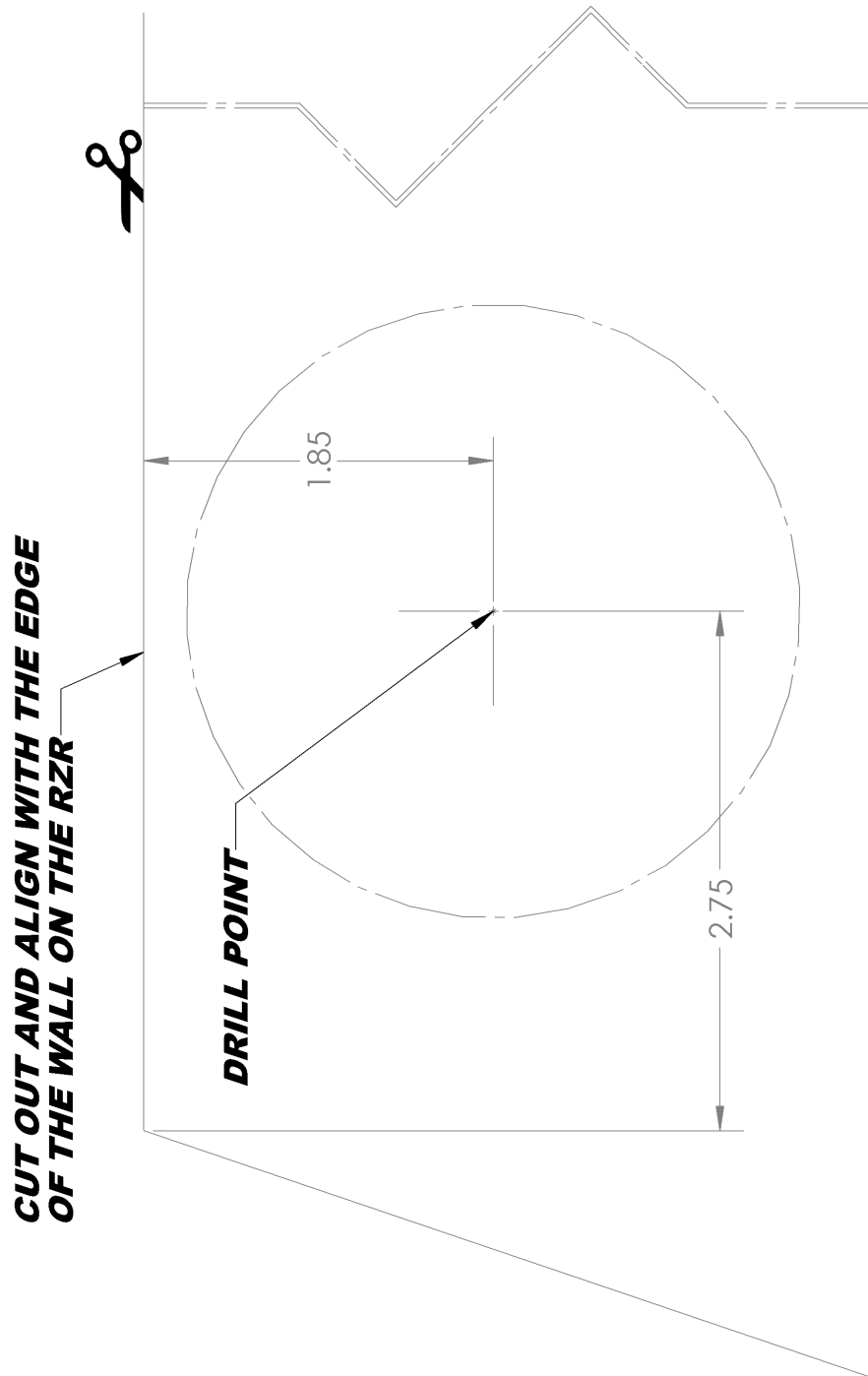

SEE EXPLODED VIEW ON PAGE 11

Page intentionally left blank

SEE EXPLODED VIEW ON PAGE 11



EXPLODED VIEW



ITEM	QTY.	DESCRIPTION	PART NUMBER
A	1	PARTICLE SEPARATOR ASSEMBLY	AL2004-00
B	2	ADAPTER, CLAMP	AI1800-00
C	2	L-BRACKET, CLAMP	AI1781-00
D	2	PIVOT, CLAMP	AI1782-00
E	2	STRAP, CLAMP	AI1795-00
F	10	WASHER, M6	AI1755-00
G	4	WASHER, M8	AI1742-00
H	6	SCREW, BHCS, M6X1.0X18	AI1802-00
I	4	SCREW, BHCS, M8X1.25X25	AI1788-00
J	2	SCREW, BHCS, M8X1.0X50	AI1801-00
K	2	LOCKNUT, M6	AI1790-00
L	1	WALL GROMMET	AI1805C-00
M	1	ADAPTER TUBE	AL1257A-00
N	1	INTAKE TUBE	AL1257-00
O	1	COUPLER	AI1806C-00
P	2	HOSE CLAMP, #52	AG1007-00
Q	1	BRACKET	AI1809-00

ITEM	QTY.	DESCRIPTION	PART NUMBER
R	1	HOSE BARB	AI1157-00
S	2	LOCK WASHER, M6	AI1685-00
T	2	HOSE CLAMP, #56	AG1019-00
U	1	DUCT	AI1735-01
V	1	SIDE COVER PLATE	AI1813-00
W	4	SCREW, BHCS, M4X14MM	AI1743-00
X	4	WASHER, M4 OVERSIZED	AI1813-00
Y	4	LOCKNUT, M4	AI1839-00
Z	1	POSI-TAP	AI1799-00
AA	1	WIRE HARNESS	AI1796-00
AB	16	CABLE TIE	AI1750-00
AC	1	VELCRO STRAP	AI1779-01
AD	1	HOLE SAW WITH ARBOR	AI1821-00
AE	1	STRAIGHT HOSE BARB	AI10749-00
AF	1	EXTENSION HOSE	AI1039-09
AG	1	THREADLOCKER, BLUE	AI1595-00